

Transit Infrastructure Cables

Solutions for Communications, Signaling,
Power, Instrumentation, & Control

The critical *Link* in your system

VITALink® • HUB-Link®

Firewall®



Marmon Electrical

A Berkshire Hathaway Company



COMTRAN
Innovative Systems. Engineered Solutions.

INTRODUCTION

ABOUT THE MANUFACTURERS

As part of Marmon Electrical, manufacturers Comtran and RSCC Wire & Cable jointly provide an extensive array of cables that deliver high performance in the most demanding applications found in the transit infrastructure environment. With the VITALink®, Firewall®, and HUB-Link® brands, Comtran and RSCC Wire & Cable offer the widest range of products to support circuits in tunnels, stations, ventilation systems, and other critical applications to keep passengers safe and moving.

OUR BRANDS

- VITALink®
- Firewall®
- HUB-Link®

APPLICATIONS

- Emergency Evacuation Systems
- Ventilation Fans
- Tunnel Lighting Circuits
- Corrosion Protection Systems
- Instrumentation Circuits
- Wayside Signaling
- Train Control Systems
- Emergency Power Circuits
- Operation and Traffic Control
- Emergency Communications & Public Address Systems
- Data Communications
- Power over Ethernet (PoE) & Point of Sale (POS) Applications
- Security & Intrusion Detection Applications
- Trackside Cases & Signaling Cabinets

KEY CERTIFICATIONS & LISTINGS

- NFPA 130
- NFPA 502
- AREMA 10.3
- Transit Specs: 940801, 82A0013, & 82A0009
- UL 2196/ULC-S139

TABLE OF CONTENTS

VITALink® Circuit Integrity Solutions	3
VITALink® MC & RC90 Transit Cables	5
VITALink® 300 RHW-2 & RW90 Cables	8
VITALink® Armored Cables	10
VITALink® Coax Cables	12
VITALink® Ethernet Cables	14
VITALink® Dual Rated CI/CIC Cables	16
Splicing Capabilities	18
Firewall® Signal, Power, & Instrumentation Solutions	20
Firewall® LSZH Signal Cables	21
Firewall® LSZH CCW Cables	23
Firewall® XHHW-2/RW90 Cables	25
Firewall® RW90 Cables	27
Firewall® RHW-2 Cables, 600V	29
Firewall® RHW-2 Cables, 2KV	31
Firewall® Tray Cables	33
Instrumentation, Unshielded	33
Instrumentation, Multi-shielded Pairs	35
Control, 600V	37
Control, 2KV	39
Power	41
HUB-Link® Signal & Communications Solutions	43
HUB-Link® Telecommunications Cables	44
HUB-Link® Data Communications Cables	46
HUB-Link® Signal Cables	48
HUB-Link® Case Wire	51

VITALink® OVERVIEW

PRODUCTS

The VITALink® brand is the most comprehensive circuit integrity product portfolio. It includes both 600V and 300V solutions for a variety of critical circuits. All of the VITALink® cabling solutions are listed to UL 2196/ULC-S139 for a complete fire-resistive cable system to ensure circuit survivability.

600V products include MC armored cables for installations in the United States and RC90 cables for installations in Canada. Standard constructions feature a LSZH jacket. VITALink® 300 is an RHW-2/RW90 cable listed for 1 hour at 480V.

VITALink® 300V products include armored cables, coaxial cables, Ethernet cables, and dual rated CI/CIC multiconductor cables.

FEATURES & BENEFITS

- Withstands temperatures up to 1850°F & ensures up to 2 hour circuit protection
- Listed for use in the United States & Canada
- Sunlight resistant & suitable for use in wet locations
- No special tools required
- No termination kits or brass fittings needed
- Installation requirements are outlined in instruction guide per UL FHIT Systems
- All required hardware components are commercially available
- Continuous long runs available
- UL/ULC Listed splices available, if required

VITALink® OVERVIEW

APPLICATIONS

VITALink® MC/RC90 Transit | VITALink® 300

- Emergency Power Circuits
- Emergency Lighting
- Ventilation Systems

VITALink® Armored

- HVAC & Smoke EVAC Control Circuits
- Generator Automatic Transfer Switches (ATS)
- Fire Alarm Backbone/Fire Alarm Control Panel

VITALink® Coax

- DAS or BDA Systems
- Emergency Responder Radio Communications (ERRC) Systems

VITALink® Ethernet

- Area of Refuge (AOR) 2-Way Communications
- Digital Signage
- IP Cameras

VITALink® Dual Rated CI/CIC

- Emergency Voice Alarm Communications (EVAC)
- Smoke & Fire Alarm Systems
- Fireman's Telephone Systems

UL/ULC CLASSIFIED SYSTEMS

- FHIT System 40A (US) & FHIT7 System 40A (Canada)
- FHIT System 40B (US) & FHIT7 System 40B (Canada)
- FHIT System 40C (US) & FHIT7 System 40C (Canada)
- FHIT Systems 120, 120A, & 60 (US) & FHIT7 Systems 120, 120A, & 60 (Canada)
- FHIT System 130 (US) & FHIT7 System 130 (Canada)

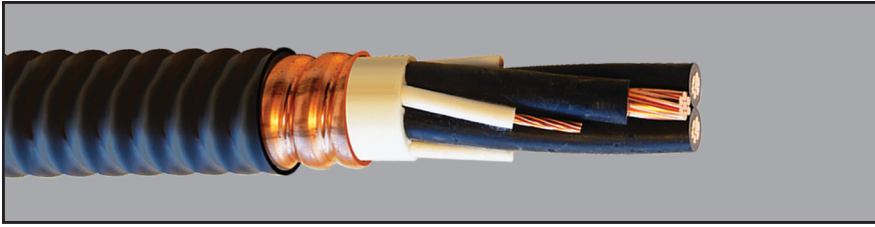

CONSTRUCTION*

- Conductors: 14 AWG - 750 kcmil Annealed Copper (Class B)
- Insulation: LSZH Ceramifiable Silicone
- Cable Assembly: 1 - 5 Conductors**
- Optional Segmented Ground Wires
- Inner Jacket: Ceramifiable Silicone Rubber
- Armor: Continuously Corrugated Welded (CCW) Copper
- Jacket: Flame Resistant LSZH (colorable)

VITALink® MC TRANSIT LISTINGS & STANDARDS For Installation in the U.S.

- UL 2196 up to 2 Hour Fire Rating for use in FHIT Systems 120, 120A, and 60 (See UL Fire Directory R15365)
- UL Listed Splice Available
- UL 1569 for Type MC
- NFPA 70, 72, 101, 130, and 502
- IEEE 1202/FT4 Vertical Flame Test; ST1 Limited Smoke
- New York City Approval
- Copper sheath exceeds the NEC requirement for equipment grounding conductor Table 250.122
- -40°C Listed
- 90°C for Wet Locations
- Sunlight Resistant

VITALink® RC90 TRANSIT LISTINGS & STANDARDS For Installation in Canada

- ULC-S139 up to 2 Hour Fire Rating for use in FHIT7 Systems 120, 120A, and 60 (See UL Fire Directory R15365)
- ULC Listed Splice Available
- cUL Type RC90 per CSA 22.2 No 123
- CSA 22.1 Article 12-700
- NFPA 130 and 502
- IEEE 1202/FT4 Vertical Flame Test; ST1 Limited Smoke
- Copper sheath can be used for equipment bonding exceeding CEC Rule 10-618 and 10-804
- NBC OS1, NBC 3.2.7.10
- -40°C Listed
- 90°C for Wet Locations
- Sunlight Resistant

*VFD constructions available upon request.

**Up to 12 conductor configurations possible. Contact us for more details.

PRODUCT MATRIX - 1, 2, & 3 CONDUCTORS

Part Number	Size (AWG/kcmil)	Number of Conductors	Nominal Core Diameter (in/mm)	Nominal Armor Diameter (in/mm)	Nominal Cable Diameter over Outer Jacket (in/mm)	Approximate Net Weight (lbs/kft)
VM011X0-200	1/0	1	0.66/16.76	1.00/25.40	1.11/28.19	935
VM012X0-200	2/0	1	0.70/17.78	1.04/26.42	1.15/29.21	1,050
VM013X0-200	3/0	1	0.75/19.05	1.08/27.43	1.18/29.97	1,190
VM014X0-200	4/0	1	0.81/20.57	1.16/29.46	1.26/32.00	1,375
VM01250-200	250	1	0.89/22.61	1.22/30.99	1.32/33.53	1,555
VM01350-200	350	1	0.99/25.15	1.35/34.29	1.45/36.83	1,955
VM01500-200	500	1	1.13/28.70	1.50/38.10	1.60/40.64	2,530
VM01750-200	750	1	1.34/34.04	1.73/43.94	1.85/46.99	3,535
VM02014-200	14	2	0.49/12.45	0.82/20.83	0.92/23.37	495
VM02012-200	12	2	0.53/13.46	0.82/20.83	0.92/23.37	520
VM02010-200	10	2	0.58/14.73	0.89/22.61	0.99/25.15	585
VM03014-200	14	3	0.52/13.21	0.82/20.83	0.92/23.37	525
VM03012-200	12	3	0.56/14.22	0.89/22.61	0.99/25.15	585
VM03010-200	10	3	0.61/15.49	0.94/23.88	1.04/26.42	660
VM03008-200	8	3	0.72/18.29	1.04/26.42	1.15/29.21	800
VM03006-200	6	3	0.80/20.32	1.16/29.46	1.26/32.00	980
VM03004-200	4	3	0.91/23.11	1.24/31.50	1.34/34.04	1,210
VM03003-200	3	3	0.97/24.64	1.30/33.02	1.40/35.56	1,365
VM03002-200	2	3	1.04/26.42	1.41/35.81	1.51/38.35	1,570
VM03001-200	1	3	1.21/30.73	1.59/40.39	1.71/43.43	1,945
VM031X0-200	1/0	3	1.29/32.77	1.67/42.42	1.79/45.47	2,230
VM032X0-200	2/0	3	1.39/35.31	1.80/45.72	1.92/48.77	2,600
VM033X0-200	3/0	3	1.49/37.85	1.92/48.77	2.04/51.82	3,030
VM034X0-200	4/0	3	1.62/41.15	2.04/51.82	2.16/54.86	3,595
VM03250-200	250	3	1.80/45.72	2.26/57.40	2.41/61.21	4,275
VM03350-200	350	3	2.02/51.31	2.48/62.99	2.63/66.80	5,460
VM03500-200	500	3	2.30/58.42	2.82/71.63	2.97/75.44	7,225

PRODUCT MATRIX - 4 & 5 CONDUCTORS

Part Number	Size (AWG/kcmil)	Number of Conductors	Nominal Core Diameter (in/mm)	Nominal Armor Diameter (in/mm)	Nominal Cable Diameter over Outer Jacket (in/mm)	Approximate Net Weight (lbs/kft)
VM04014-200	14	4	0.57/14.48	0.89/22.61	0.99/25.15	590
VM04012-200	12	4	0.62/15.75	0.94/23.88	1.04/26.42	660
VM04010-200	10	4	0.67/17.02	1.00/25.40	1.11/28.19	755
VM04008-200	8	4	0.80/20.32	1.16/29.46	1.26/32.00	955
VM04006-200	6	4	0.89/22.61	1.22/30.99	1.32/33.53	1,340
VM04004-200	4	4	1.00/25.40	1.35/34.29	1.45/36.83	1,450
VM04003-200	3	4	1.07/27.18	1.41/35.82	1.51/38.35	1,645
VM04002-200	2	4	1.15/29.21	1.50/38.10	1.60/40.64	1,890
VM04001-200	1	4	1.34/34.04	1.73/43.94	1.85/46.99	2,375
VM041X0-200	1/0	4	1.43/36.32	1.82/46.23	1.94/49.28	2,745
VM042X0-200	2/0	4	1.54/39.12	1.95/49.53	2.07/52.58	3,215
VM043X0-200	3/0	4	1.68/42.67	2.12/53.85	2.25/57.15	3,830
VM044X0-200	4/0	4	1.82/46.23	2.26/57.40	2.41/61.21	4,610
VM04250-200	250	4	2.00/50.80	2.46/62.48	2.63/66.80	5,365
VM04350-200	350	4	2.25/57.15	2.71/68.83	2.86/72.64	6,905
VM04500-200	500	4	2.60/66.04	3.13/79.50	3.30/83.82	9,370
VM05014-200	14	5	0.63/16.00	0.94/23.88	1.04/26.42	645
VM05012-200	12	5	0.68/17.27	1.00/25.40	1.11/28.19	735
VM05010-200	10	5	0.74/18.80	1.08/27.43	1.18/29.97	850
VM05008-200	8	5	0.88/22.35	1.22/30.99	1.32/33.53	1,075
VM05006-200	6	5	0.99/25.15	1.30/33.02	1.40/35.56	1,315
VM05004-200	4	5	1.11/28.19	1.48/37.59	1.58/40.13	1,705

VITALink® 300 RHW-2/RW90

600 Volts

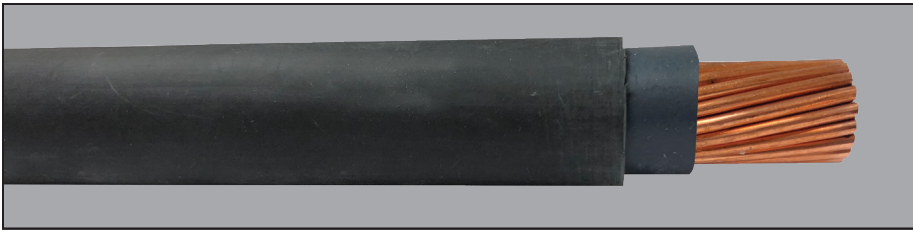

CONSTRUCTION

- Conductor: 12 AWG - 2 AWG Bare Copper (Class B)
- Insulation: Two Layer Composite Construction
 - Inner Layer: Proprietary LSZH Thermoset Fire-Roc®
 - Outer Layer: Black LSZH Crosslinked Polyolefin (XLPO)

LISTINGS & STANDARDS

- UL 2196/ULC-S139 for 1 hour at 480V for use with Champion Flame Shield Phenolic Conduit Type XW per FHIT/FHIT7 System 130
- UL/ULC Listed Splice Available
- UL/cUL Listed, NEC and CE Code Types RHW-2/RW90 in accordance with UL Standard No. 44/CSA 22.8.38
- UL Listed FT4/IEEE 1202 Vertical Flame Test
- UL Listed as ST1 per UL 44 and UL 2556/1685 (FT4 Method), meeting smoke and flame requirements of NFPA 130
- UL Listed 90°C for Wet and Dry Locations
- UL Listed as -40°C
- UL Listed as Gasoline and Oil Resistant Type II
- UL Listed as Sunlight Resistant
- Low Toxicity Index per NES 713

PRODUCT MATRIX

Part Number	Size (AWG/kcmil)	Number of Strands	Nominal Diameter (in/mm)	Approximate Net Weight (lbs/kft)	Ampacity* (amperes)
VR01012-300	12	7	0.21/5.33	39	20**
VR01010-300	10	7	0.24/6.10	54	30**
VR01008-300	8	7	0.30/7.62	84	55
VR01006-300	6	7	0.36/9.14	126	75
VR01004-300	4	7	0.41/10.41	182	95
VR01003-300	3	7	0.44/11.18	220	115
VR01002-300	2	7	0.47/11.94	268	130

*Ampacity is based on Table 310.15(B)(16) of the National Electrical Code (NEC) based on the 90°C column with 30°C ambient, and 3 current carrying conductors. Temperature limitations per 110.14 of the NEC needs to be considered. Table does not take into consideration voltage drop or fault current capability.

**Ampacity shown for 12 and 10 AWG conductors is limited by NEC section 240.4(D)

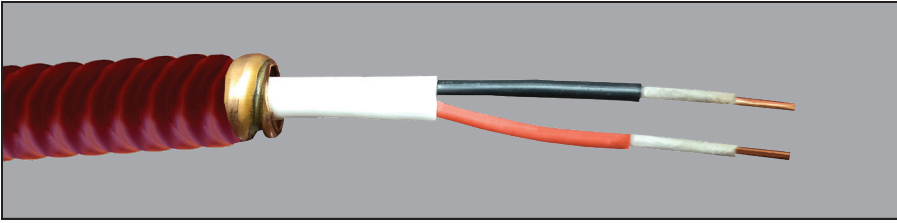

CONSTRUCTION

- Conductors: 16 AWG & 14 AWG Solid Bare Copper
- Tape: Flame Retardant Tape
- Insulation: LSZH Thermoset Fire-Roc®
- Cable Assembly: 2-8 Conductors
- Shield 1: Copper/Polyester Tape (Shielded constructions only)
- Drain Wire: 16 AWG Stranded Bare Copper (Shielded constructions only)
- Shield 2: Copper/Polyester Tape (Shielded constructions only)
- Binder: Black or White Fire-Roc®
- Armor: Continuously Corrugated Welded (CCW) Copper
- Jacket: Black or Red Non-Halogen Flame Retardant Polyolefin (Sequential footage markers every 2 feet)
- Non-jacketed constructions available
- Alternative jacket colors & non-black jacket striping (on the outside of the armor or jacket) available upon request

LISTINGS & STANDARDS

- UL 2196 2 Hour Fire Rating for use in FHIT System 40B (See UL Fire Directory R27557)
- ULC-S139 2 Hour Fire Rating for use in FHIT7 System 40B
- UL Type FPLR-ST1 and CL3R-ST1
- CSA Listed FAS 105 ST1 FT4
- UL 1424 Power-Limited Fire Alarm Circuits; 300V/105°C
- UL 13 Power-Limited Circuit Cables; 300V/105°C
- CSA 22.2 No. 218 Fire Alarm and Signal Cable; 300V/105°C
- Fire Certified for Power-Limited System Use at 72V Phase-to-Phase Utilization Voltage
- NFPA 70, 72, 130, and 502
- California State Fire Marshal Approved
- RoHS Compliant

PRODUCT MATRIX

Part Number	Number of Conductors	Nominal Core Diameter (in/mm)	Nominal Armor Diameter (in/mm)	Nominal Cable Diameter over Outer Jacket (in/mm)	Approximate Net Weight (Lbs/1000 ft.)
14 AWG Armored - With Overall Jacket					
36520	2	0.334/8.484	0.620/15.748	0.684/17.374	306
36730	3	0.377/9.576	0.700/17.780	0.795/20.193	440
36521	4	0.504/12.802	0.840/21.336	0.934/23.724	532
36731	5	0.463/11.760	0.780/19.812	0.874/22.200	515
36522	6	0.538/13.665	0.880/22.352	0.974/24.740	601
36732	7	0.506/12.852	0.820/20.828	0.914/23.216	565
36523	8	0.605/15.367	0.920/23.368	1.024/26.100	682
16 AWG Shielded & Armored - With Overall Jacket					
36742	2	0.370/9.398	0.660/16.764	0.724/18.390	346
36743	3	0.372/9.449	0.660/16.764	0.724/18.390	373
36744	4	0.740/18.796	1.043/26.492	1.167/29.642	620
36745	5	0.450/11.430	0.780/19.812	0.844/21.438	470
36746	6	0.799/20.295	1.155/29.337	1.279/32.487	736
36747	7	0.471/11.963	0.840/21.336	0.934/23.724	563
36748	8	0.860/21.844	1.220/30.988	1.344/34.14	826

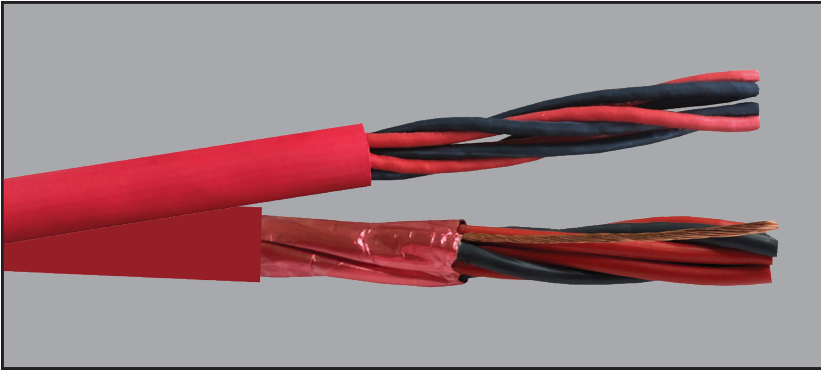

CONSTRUCTION

- Conductors: 18 AWG Solid Bare Copper
- Tape: Flame Retardant Tape
- Insulation: LSZH Thermoset Fire-Roc®
- Cable Assembly: 2 - 4 Pairs
- Drain Wire: 18 AWG Stranded Bare Copper (Shielded constructions only)
- Shield: Copper Shield (Shielded constructions only)
- Jacket: Red Non-Halogen Flame Retardant Polyolefin (Sequential footage markers every 2 feet)
- Alternative jacket colors & non-black jacket striping available upon request
- Patent Pending

LISTINGS & STANDARDS

- UL 2196 2 Hour Fire Rating for use in FHIT System 40A (See UL Fire Directory R27557)
- ULC-S139 2 Hour Fire Rating for use in FHIT7 System 40A
- UL Type FPLR-ST1 (Shielded constructions only) and CL3R-ST1
- c(UL)us Type CMR-ST1
- CSA Listed FAS 105 ST1 FT4 (Shielded constructions only)
- UL 1424 for Power-Limited Fire Alarm Cables; 300V / 105°C (Shielded constructions only)
- UL 13 for Power-Limited Circuit Cables; 300V / 105°C
- UL 444 for Communication Cable; 300V / 105°C
- CSA 22.2 No. 218 Fire Alarm and Signal Cable; 300V/105°C
- NFPA 70, 72, 130, and 502
- Meets Cat 3 Channel Requirements
- Transmits data speeds up to 10 Mbps
- Fire Certified for Power-Limited System Use at 72V Phase-to-Phase Utilization Voltage (Shielded constructions only)
- Sunlight Resistant
- For use in Wet Locations
- California State Fire Marshal Approved
- RoHS Compliant

PRODUCT MATRIX

Part Number	Size (AWG)	Number of Pairs	Nominal Diameter (in/mm)	Approximate Net Weight (lbs/kft)	Nominal Capacitance (pF/ft)
Shielded					
36512	18	2	0.465/11.81	95	18
36530	18	3	0.489/12.42	113	18
36513	18	4	0.510/12.95	126	18
Unshielded					
36608	18	2	0.357/9.07	56	17
36610	18	3	0.379/9.63	71	17
36609	18	4	0.417/10.59	93	17

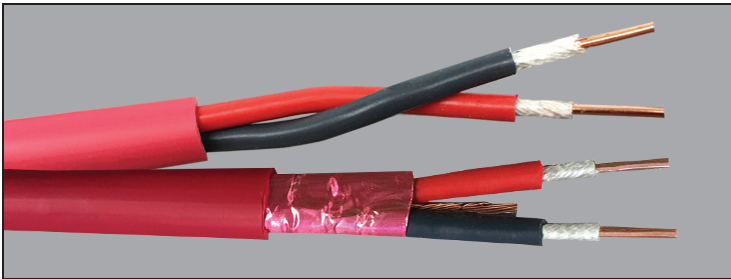

CONSTRUCTION

- Conductors: 18 - 12 AWG Solid Bare Copper and 16 - 12 AWG Stranded Bare Copper
- Insulation: LSZH Thermoset Fire-Roc®
- Tape: Flame Retardant Tape
- Cable Assembly: 2 Conductors
- Drain Wire: Stranded Bare Copper (Shielded constructions only)
- Shield: Copper/Polyester Tape (Shielded constructions only)
- Jacket: Red Non-Halogen Flame Retardant Polyolefin (Sequential footage markers every 2 feet)
- Alternative jacket colors & non-black jacket striping available upon request

LISTINGS & STANDARDS

- UL 2196 2 Hour Fire Rating for use in FHIT System 40A (See UL Fire Directory R27557)
- ULC-S139 2 Hour Fire Rating for use in FHIT7 System 40A
- UL/ULC Listed Splice Available
- UL Type FPLR-CI-ST1, CMR-CI-ST1, and CL3R-CI-ST1
- CSA Listed FAS 105 ST1 FT4
- UL 1424 for Power-Limited Fire Alarm Cables; 300V / 105°C
- UL 13 for Power-Limited Circuit Cables; 300V / 105°C
- UL 444 for Communication Cable; 300V / 105°C
- CSA 22.2 No. 218 Fire Alarm and Signal Cable; 300V/105°C
- NFPA 70, 72, 130, and 502
- Fire Certified for Power-Limited System Use at 72V Phase-to-Phase Utilization Voltage
- Sunlight Resistant
- For use in Wet Locations
- NYC Electrical Advisory Board approval #54502, April 2017
- California State Fire Marshal Approved
- RoHS Compliant

CIRCUIT INTEGRITY (CI) vs. CIRCUIT INTEGRITY IN CONDUIT (CIC)

Rated as both Circuit Integrity (CI) and Circuit Integrity in Conduit (CIC), VITALink® CI/CIC cables can be installed either with or without conduit, depending on the application and code requirements. As CI, also referred to as CI Free Air, VITALink® can be used in riser or horizontal (non-plenum) installations without conduit. The cable must be installed per the NEC code and meet all national and local code requirements.

As CIC, VITALink® cable must be installed per the UL listed FHIT System 40A or FHIT7 System 40A and in accordance with the manufacturer's installation instructions. These systems require use of specific hardware including conduit, couplings, pulling lubricant, pull boxes, and supports. In areas such as plenum airspace, VITALink® must be installed in conduit.

**This acronym is not to be confused with the abbreviation for control & instrumentation cable in Canada. VITALink® CIC cables are for circuit integrity applications when installed in conduit.*

PRODUCT MATRIX

Part Number	Size (AWG)	Number of Conductors	Solid or Stranded Conductors	Nominal Diameter (in/mm)	Approximate Net Weight (lbs/kft)	Nominal Capacitance (pF/ft)
Shielded						
36397	18	2	Solid	0.309/7.85	49	21
35785	16	2	Solid	0.330/8.38	60	20
36316	14	2	Solid	0.359/9.12	73	25
Unshielded						
36337	18	2	Solid	0.305/7.75	41	13
35777	16	2	Solid	0.321/8.15	52	19
36341	16	2	Stranded	0.344/8.74	54	19
36338	14	2	Solid	0.352/8.94	61	20
36340	14	2	Stranded	0.368/9.38	65	20
36342	12	2	Solid	0.402/10.21	90	22
36339	12	2	Stranded	0.413/10.49	92	22

SPLICING CAPABILITIES

VITALink® MC/RC90 TRANSIT

STRAIGHT TAPE SPLICE

- FHIT/FHIT7 System 120
- 2 Hour Rating
- 600 Volts
- 8 AWG to 750 MCM
- Instruction Manual IM-120-1

BLOCK SPLICE

- FHIT/FHIT7 System 120A
- 2 Hour Rating
- 480 Volts
- 14 AWG to 2 AWG
- Instruction Manual IM-120-2

FUSED BLOCK SPLICE

- FHIT/FHIT7 System 60
- 1 Hour Rating
- 600 Volts
- 12 AWG to 2 AWG
- Instruction Manual IM-60-1

PIGTAIL TAPE SPLICE

- FHIT/FHIT7 System 60
- 1 Hour Rating
- 480 Volts
- 14 AWG to 2 AWG
- Instruction Manual IM-60-2

Straight Tape Splice

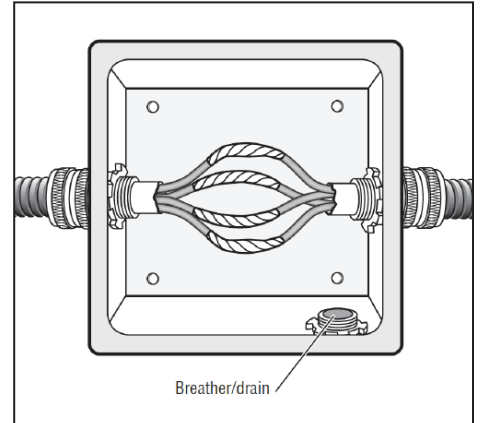

Block Splice

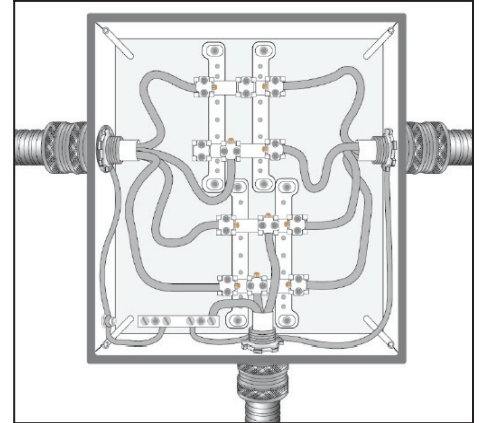

Fused Block Splice

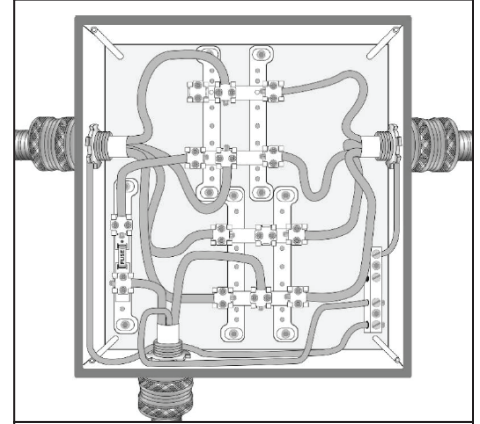

Pigtail Tape Splice

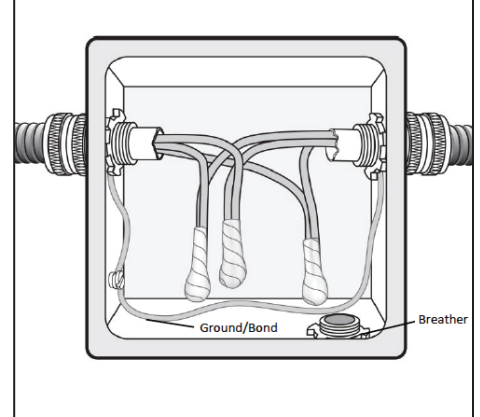

SPLICING CAPABILITIES

VITALink® 300

PIGTAIL TAPE SPLICE

- FHIT/FHIT7 System 130
- 1 Hour Rating
- 480 Volts
- 12 AWG to 2 AWG
- Instruction Manual IM-130-1

VITALink® DUAL RATED CI/CIC

PIGTAIL TAPE SPLICE

- FHIT/FHIT7 System 40A
- 2 Hour Rating
- 72 Volts
- 18 AWG to 12 AWG
- Instruction Manual Available

OTHER DETAILS

Any required materials are listed in each installation manual. Additional tools may be required, such as:

- Utility Knife
- Pipe Cutter
- Cable Cutter
- Socket Wrench
- Screw Driver
- Crimper
- Needle Nose Pliers
- Channel Locks

For more information regarding splicing or to request a copy of the installation manuals, please contact us.

FIREWALL® OVERVIEW

PRODUCTS

The Firewall® brand consists of a variety of cabling solutions that support critical functions in the transit infrastructure, including power, lighting, and instrumentation circuits. Firewall® products are LZSH and designed to withstand rugged underground conditions. Cables rated for 600V, 1KV, and 2KV are available.

FEATURES & BENEFITS

- Sunlight Resistant
- UL Approved for 90°C for Wet and Dry Locations
- UL Listed as ST1 (Limited Smoke) per UL 2556/1685 with IEEE 1202/FT4 Flame Method
- AREMA Standards 10.3.16, 10.3.26, and 10.3.13
- Meets the requirements of NFPA 130 & 502

APPLICATIONS

Firewall® Signal Cables

- Signaling Functions
- Train Control

Firewall® XHHW-2 & RHW-2 Cables

- Power & Lighting Functions
- Non-Emergency Ventilation Systems
- HVAC Systems

Firewall® Tray Cables

- Control Circuits
- Dampers & Doors
- Fan Circuits
- Signage & Public Address Devices

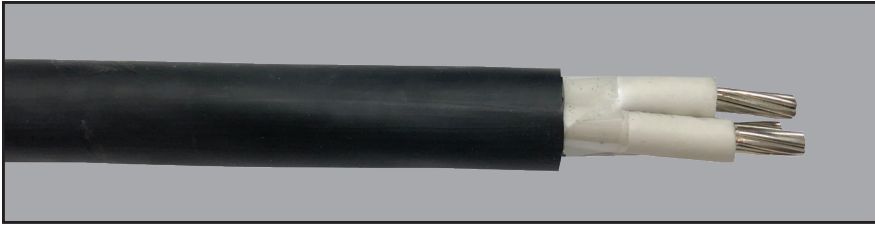

CONSTRUCTION*

- Conductors: 14, 9, 6, and 4 AWG Tin Coated Copper (Class C)
- Insulation: Flame Retardant LSZH Crosslinked Polyolefin
- Cable Assembly: 2 - 37 Conductors
- Circuit Identification: Printed Numbers per ICEA S-73-532 Method 4.
- Fillers: Where required
- Binder Tape: Helically Applied Polyester
- Jacket: Black Flame Retardant LSZH Crosslinked Polyolefin

LISTINGS & STANDARDS

- Insulation in accordance with ICEA, UL, and AREMA 10.3.26 2019 Class 2 Standards
- Insulation thickness per AREMA 10.3.16 2019 Type VI LSZH AERIAL
- Jacket in accordance with ICEA, UL, and AREMA 10.3.13 Thermosetting Jacket
- Jacket thickness per AREMA 10.3.16 2019 Type IV
- Insulated conductors are UL Listed Type RHW-2
- UL Listed Type TC (UL 1277) in accordance with NEC
- UL Listed as ST1 (Limited Smoke) per UL 2556/1685 with IEEE 1202/FT4 FI me Method
- UL Approved 90°C for Wet and Dry Locations
- Jacket exceeds requirements for UL Class XL/90°C and ICEA Publication T-33-655, Type II
- UL Listed for Sunlight Resistance
- UL Listed for Direct Burial
- Meets the requirements of NFPA 130
- Passes Long-Term Water Test per AREMA 10.3.26
- Insulation and Jacket Toxicity Index does not exceed 2.0% per NES 713
- Insulation and Jacket Halogen Content does not exceed 0.2% per MIL-DTL-24643
- Insulation and Jacket Acid Gas Content does not exceed 2.0% per MIL-DTL-24643

PRODUCT MATRIX

Part Number	Number of Conductors	Size (AWG)	Nominal Conductor Overall Diameter (inch)	Nominal Wall (inch)	Nominal Insulation Overall Diameter (inch)	Jacket Thickness (inch)	Overall Diameter (inch)	Approximate Net Weight (lbs/kft)
EZ02014-700	2	14	0.067	0.045	0.160	0.060	0.45	101
EZ03014-700	3	14	0.067	0.045	0.160	0.060	0.47	128
EZ04014-700	4	14	0.067	0.045	0.160	0.060	0.51	157
EZ05014-700	5	14	0.067	0.045	0.160	0.080	0.60	207
EZ07014-700	7	14	0.067	0.045	0.160	0.080	0.65	262
EZ09014-700	9	14	0.067	0.045	0.160	0.080	0.81	338
EZ10014-700	10	14	0.067	0.045	0.160	0.080	0.81	361
EZ12014-700	12	14	0.067	0.045	0.160	0.080	0.83	413
EZ19014-700	19	14	0.067	0.045	0.160	0.095	1.00	631
EZ27014-700	27	14	0.067	0.045	0.160	0.095	1.18	859
EZ37014-700	37	14	0.067	0.045	0.160	0.110	1.35	1163
EZ02009-700	2	9	0.126	0.045	0.22	0.080	0.60	215
EZ03009-700	3	9	0.126	0.045	0.22	0.080	0.64	280
EZ04009-700	4	9	0.126	0.045	0.22	0.080	0.70	351
EZ05009-700	5	9	0.126	0.045	0.22	0.080	0.76	413
EZ07009-700	7	9	0.126	0.045	0.22	0.080	0.82	543
EZ09009-700	9	9	0.126	0.045	0.22	0.095	1.07	736
EZ12009-700	12	9	0.126	0.045	0.22	0.095	1.10	919
EZ15009-700	15	9	0.126	0.045	0.22	0.095	1.22	1123
EZ02006-700	2	6	0.184	0.060	0.31	0.080	0.78	368
EZ03006-700	3	6	0.184	0.060	0.31	0.080	0.83	494
EZ04006-700	4	6	0.184	0.060	0.31	0.095	0.94	657
EZ05006-700	5	6	0.184	0.060	0.31	0.095	1.03	777
EZ04004-700	4	4	0.227	0.080	0.39	0.095	1.14	999

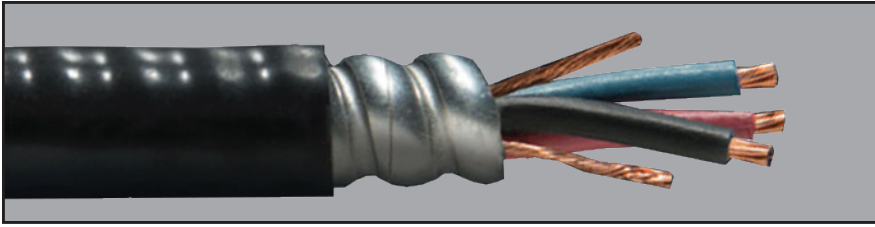

CONSTRUCTION

- Conductor: 14 AWG - 750 kcmil Tin Coated Copper (Class B)
- Insulation: Flame Retardant LSZH Crosslinked Polyolefin
- Cable Assembly: 3 & 4 Conductors*
- Circuit Identification: Printed numbers per ICEA Method 4 (Alternative colors available upon request)
- Fillers: Where required
- Binder Tape: Helically Applied Polyester
- Ground Wire(s): Annealed Copper Class B to comply with NEC requirements
- Armor: Continuously Corrugated Welded (CCW) Aluminum
- Jacket: Black Flame Retardant LSZH Crosslinked Polyolefin

LISTINGS & STANDARDS

- Insulation in accordance with ICEA and UL standards
- Insulation is Oil and Gasoline Resistant
- Insulated conductors are UL Listed Type RFHH-2
- UL Listed Type MC (UL 1569) in accordance with NEC
- Passes IEEE 1202/FT4 Vertical Tray Flame Test and ICEA 70,000 BTU/hr Vertical Tray Flame Test (T-30-520)
- Single conductors pass Vertical Flame Test Type A as defined in ICEA S-95-658 (6.8.2)
- UL Listed s ST1 (Limited Smoke) per UL 2556/1685
- UL Approved 90°C for Wet and Dry Locations
- Jacket exceeds requirements for UL Class XL/90°C and ICEA Publication T-33-655, Type II
- UL Listed for Sunlight Resistance
- Meets the requirements of NFPA 130 & 502
- Passes Long-Term Water Test per AREMA 10.3.26

PRODUCT MATRIX

Part Number	Size (AWG/kcmil)	Insulation Thickness (inch) (mm)		Ground Wires Qty-Size	Core Diameter (inch)	Armor Thickness (mils)	Armor Overall Diameter (inch)	Jacket Thickness (mils)	Nominal Overall Diameter (inch) (mm)		Approximate Net Weight (lbs/kft)
3 Conductors											
TG03014-020	14	.030	.76	3-18	.29	25	.48	50	.58	14.7	170
TG03012-020	12	.030	.76	3-16	.33	25	.54	50	.64	16.3	220
TG03010-020	10	.030	.76	3-14	.38	25	.58	50	.68	17.3	280
TG03008-020	8	.045	1.14	3-14	.52	25	.74	50	.84	21.3	398
TG03006-020	6	.045	1.14	3-12	.60	25	.84	50	.95	24.1	549
TG03004-020	4	.045	1.14	3-12	.70	25	.97	50	1.07	27.2	732
TG03002-020	2	.045	1.14	3-10	.83	25	1.13	50	1.23	31.2	1052
TG031X0-020	1/0	.055	1.40	3-10	1.04	25	1.33	50	1.44	36.6	1512
TG032X0-020	2/0	.055	1.40	3-10	1.14	25	1.46	50	1.57	39.9	1813
TG033X0-020	3/0	.055	1.40	3-8	1.25	25	1.56	60	1.69	42.9	2280
TG034X0-020	4/0	.055	1.40	3-8	1.37	25	1.71	60	1.84	46.7	2743
TG03250-020	250	.065	1.65	3-8	1.53	32	1.87	60	2.00	50.8	3258
TG03350-020	350	.065	1.65	3-6	1.75	32	2.25	60	2.37	57.2	4424
TG03500-020	500	.065	1.65	3-6	2.03	32	2.47	75	2.63	66.8	6056
TG03750-020	750	.080	2.03	3-4	2.48	32	3.03	85	3.21	81.5	8873
4 Conductors											
TG04014-020	14	.030	.76	2-16	.33	25	.54	50	.64	16.3	199
TG04012-020	12	.030	.76	3-16	.37	25	.58	50	.68	17.3	256
TG04010-020	10	.030	.76	3-14	.43	25	.62	50	.72	18.3	330
TG04008-020	8	.045	1.14	2-12	.58	25	.84	50	.95	24.1	488
TG04006-020	6	.045	1.14	2-10	.67	25	.92	50	1.02	25.9	667
TG04004-020	4	.045	1.14	2-10	.78	25	1.07	50	1.17	29.7	912
TG04002-020	2	.045	1.14	2-8	.93	25	1.19	50	1.29	32.8	1309
TG041X0-020	1/0	.055	1.40	1-6	1.17	25	1.46	50	1.57	39.9	1902
TG042X0-020	2/0	.055	1.40	1-6	1.28	25	1.64	60	1.77	45.0	2340
TG043X0-020	3/0	.055	1.40	1-4	1.40	32	1.80	60	1.92	48.8	2966
TG044X0-020	4/0	.055	1.40	1-4	1.55	32	1.94	60	2.06	52.3	3558
TG04250-020	250	.065	1.65	1-4	1.72	32	2.12	60	2.25	57.2	4153
TG04350-020	350	.065	1.65	1-3	1.96	32	2.41	75	2.56	66.8	5657
TG04500-020	500	.065	1.65	1-2	2.27	32	2.71	75	2.87	72.9	7780

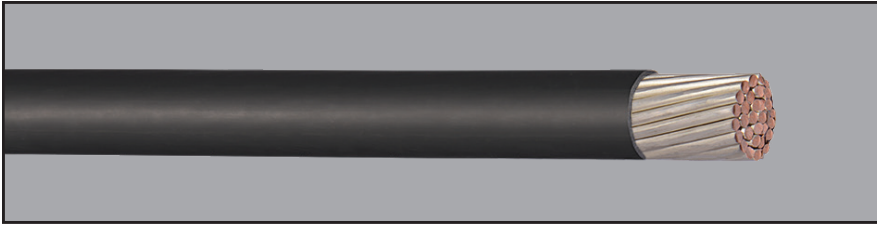

CONSTRUCTION

- Conductor: 14 AWG - 750 kcmil Tin Coated Copper (Class B). Available as solid conductors when required.
- Insulation: Flame Retardant LSZH Crosslinked Polyolefin
- Separator Tape: Helically Applied Polyester (Where required)
- Color: Black (Available in alternative colors or colored stripes)

LISTINGS & STANDARDS

- UL Listed as XHHW-2 per UL 44
- cUL Listed Type RW90 (CSA 22.2 No.38) in accordance with CEC
- LSZH Insulation per ICEA S-73-532
- Insulation is Oil and Gasoline Resistant
- UL Listed Type CT (UL 44) in accordance with NEC on 1/0 AWG and larger
- Passes IEEE 1202/FT4 Vertical Tray Flame Test and ICEA 70,000 BTU/hr Vertical Flame Test
- Passes UL VW-1*
- Passes Vertical Flame Test Type A as defined in ICEA S-95-658 (6.8.2)
- UL Listed for Sunlight Resistance (Black Only)
- UL & cUL Listed as ST1 (Limited Smoke) per UL 2556/1685
- UL & cUL Approved 90°C** for Wet and Dry Locations
- Meets the requirements of NFPA 130 & 502 as applicable
- Passes Long-Term Water Test per AREMA 10.3.26

*10 AWG and larger

**Rated 90°C for normal operation in wet and dry locations, 130°C for emergency overload conditions, and 250°C for short circuit conditions.

PRODUCT MATRIX

Part Number	Size (AWG/kcmil)	Number of Strands	Insulation Thickness		Nominal Overall Diameter		Approximate Net Weight (lbs/kft)
			(inch)	(mm)	(inch)	(mm)	
P46-2180*	18	Solid	.030	.76	.10	2.6	10
P46-2160*	16	Solid	.030	.76	.11	2.9	13
P46-2140	14	Solid	.030	.76	.13	3.2	18
P46-2120	12	Solid	.030	.76	.14	3.6	27
P46-2110	10	Solid	.030	.76	.16	4.2	39
P46-0180*	18	7	.030	.76	.11	2.7	10
P46-0160*	16	7	.030	.76	.12	3.0	14
P46-0140	14	7	.030	.76	.13	3.3	19
P46-0120	12	7	.030	.76	.15	3.8	28
P46-0110	10	7	.030	.76	.18	4.6	40
P46-0080	8	7	.045	1.14	.24	6.1	70
P46-0060	6	7	.045	1.14	.27	6.9	105
P46-0040	4	7	.045	1.14	.32	8.1	160
P46-0020	2	7	.045	1.14	.38	9.7	240
P46-0010	1	19	.055	1.40	.44	11.2	305
P46-0100	1/0	19	.055	1.40	.48	12.2	375
P46-0200	2/0	19	.055	1.40	.52	13.2	470
P46-0300	3/0	19	.055	1.40	.57	14.5	590
P46-0400	4/0	19	.055	1.40	.63	16.0	730
P46-0250	250	37	.065	2.41	.70	17.8	870
P46-0350	350	37	.065	2.41	.80	20.3	1200
P46-0500	500	37	.065	2.41	.93	23.6	1680
P46-0600	600	61	.080	2.79	1.05	26.7	2031
P46-0750	750	61	.080	2.79	1.14	28.9	2499

*UL does not list Type XHHW-2 smaller than 14 AWG. 16 AWG and 18 AWG are UL Listed Type RFHH-2, 90°C Wet and Dry, NFPA 130 and NFPA 502 Compliant.

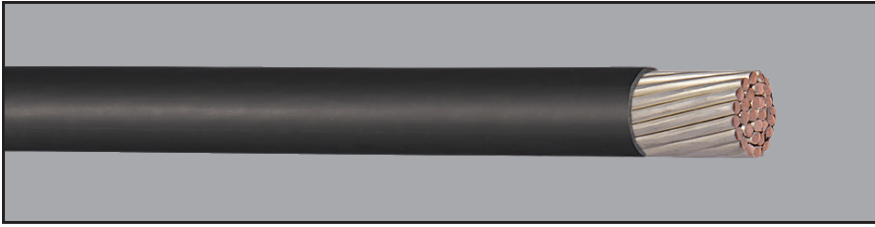

CONSTRUCTION

- Conductor: 14 AWG - 750 kcmil Tin Coated Copper (Class B). Available as solid conductors when required.
- Insulation: Flame Retardant LSZH Crosslinked Polyolefin
- Separator Tape: Helically Applied Polyester (Where required)
- Color: Black (Available in alternative colors or colored stripes)

LISTINGS & STANDARDS

- Insulation in accordance with ICEA and CEC standards
- Insulation is Oil and Gasoline Resistant
- cUL Listed Type RW90 (CSA 22.2 No.38) in accordance with CEC
- Passes IEEE 1202/FT4 Vertical Tray Flame Test and ICEA 70,000 BTU/hr Vertical Flame Test
- Passes Vertical Flame Test Type A as defined in ICEA S-95-658 (6.8.2)
- cUL Listed as ST1 (Limited Smoke) per UL 2556/1685
- cUL Approved 90°C* for Wet and Dry Locations
- Meets the requirements of NFPA 130 & 502
- Passes UL VW-1**
- Passes Long-Term Water Test per AREMA 10.3.26

**Rated 90°C for normal operation in wet and dry locations, 130°C for emergency overload conditions, and 250°C for short circuit conditions.*

PRODUCT MATRIX

Part Number	Size (AWG/kcmil)	Number of Strands	Insulation Thickness		Nominal Overall Diameter		Approximate Net Weight (lbs/kft)
			(inch)	(mm)	(inch)	(mm)	
P48-9140	14	7	.045	1.14	.16	4.1	24
P48-9120	12	7	.045	1.14	.18	4.6	34
P48-9110	10	7	.045	1.14	.21	5.3	48
P48-9080	8	7	.045	1.14	.24	6.1	70
P48-9060	6	7	.060	1.52	.3	7.6	114
P48-9040	4	7	.060	1.52	.35	8.9	170
P48-9030	3	7	.060	1.52	.38	9.7	206
P48-9020	2	7	.060	1.52	.41	10.41	251
P48-9010	1	19	.080	2.03	.49	12.4	332
P48-9100	1/0	19	.080	2.03	.53	13.5	406
P48-9200	2/0	19	.080	2.03	.57	14.5	501
P48-9300	3/0	19	.080	2.03	.62	15.7	619
P48-9400	4/0	19	.080	2.03	.68	17.3	765
P48-9250	250	37	.090	2.28	.75	19.1	900
P48-9350	350	37	.090	2.28	.85	21.6	1225
P48-9500	500	37	.090	2.28	.98	24.9	1725
P48-9600	600	61	.090	2.28	1.07	27.2	2040
P48-9750	750	61	.090	2.28	1.16	29.5	2575

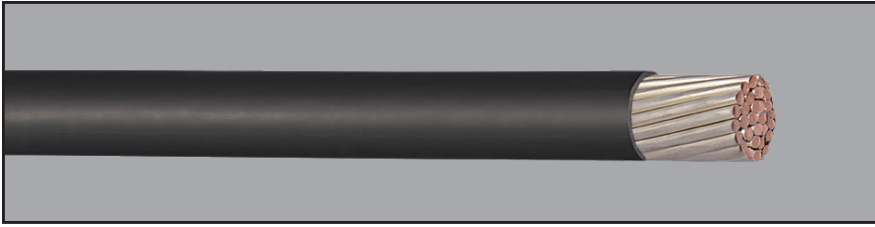

CONSTRUCTION

- Conductor: 14 AWG - 750 kcmil Tin Coated Copper (Class B). Available as solid conductors when required.
- Insulation: Flame Retardant LSZH Crosslinked Polyolefin
- Separator Tape: Helically Applied Polyester (Where required)
- Color: Black (Available in alternative colors or colored stripes)

LISTINGS & STANDARDS

- UL Listed as RHW-2 per UL 44
- LSZH Insulation per ICEA S-73-532
- Insulation is Oil and Gasoline Resistant
- Passes IEEE 1202/FT4 Vertical Tray Flame Test and ICEA 70,000 BTU/hr Vertical Tray Flame Test (T-30-520)
- Passes Vertical Flame Test Type A as defined in ICEA S-95-658 (6.8.2)
- UL Listed as ST1 (Limited Smoke) per UL 2556/1685
- UL Approved 90°C* for Wet and Dry Locations
- UL Listed for Sunlight Resistance (Black Only)
- Meets the requirements of NFPA 130 & 502
- Passes UL VW-1**
- For tray installation, 1/0 AWG and larger (CT USE)
- Listed as USE-2 Underground Service Entrance cable
- Passes Long-Term Water Test per AREMA 10.3.26

**Rated 90°C for normal operation in wet and dry locations, 130°C for emergency overload conditions, and 250°C for short circuit conditions.*

***10 AWG and larger*

PRODUCT MATRIX

Part Number	Size (AWG/kcmil)	Number of Strands	Insulation Thickness		Nominal Overall Diameter		Approximate Net Weight (lbs/kft)
			(inch)	(mm)	(inch)	(mm)	
P47-6140	14	7	.045	1.14	.16	4.1	24
P47-6120	12	7	.045	1.14	.18	4.6	34
P47-6110	10	7	.045	1.14	.21	5.3	48
P47-6080	8	7	.060	1.52	.27	6.9	79
P47-6060	6	7	.060	1.52	.3	7.6	114
P47-6040	4	7	.060	1.52	.35	8.9	170
P47-6030	3	7	.060	1.52	.38	9.7	206
P47-6020	2	7	.060	1.52	.41	10.41	251
P47-6010	1	19	.080	2.03	.49	12.4	332
P47-6100	1/0	19	.080	2.03	.53	13.5	406
P47-6200	2/0	19	.080	2.03	.57	14.5	501
P47-6300	3/0	19	.080	2.03	.62	15.7	619
P47-6400	4/0	19	.080	2.03	.68	17.3	765
P47-6250	250	37	.095	2.41	.76	19.3	918
P47-6350	350	37	.095	2.41	.86	21.8	1254
P47-6500	500	37	.095	2.41	.99	25.1	1751
P47-6600	600	61	.110	2.79	1.11	28.19	2049
P47-6750	750	61	.110	2.79	1.2	30.5	2613

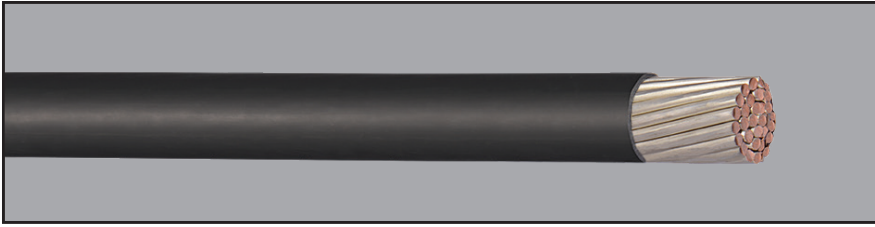

CONSTRUCTION

- Conductor: 14 AWG - 750 kcmil Tin Coated Copper (Class B). Available as solid conductors when required.
- Insulation: Flame Retardant LSZH Crosslinked Polyolefin
- Separator Tape: Helically Applied Polyester (Where required)
- Color: Black (Available in alternative colors or colored stripes)

LISTINGS & STANDARDS

- UL Listed as RHW-2 per UL 44
- LSZH Insulation per ICEA S-73-532
- Insulation is Oil and Gasoline Resistant
- Passes IEEE 1202/FT4 Vertical Tray Flame Test and ICEA 70,000 BTU/hr Vertical Tray Flame Test (T-30-520)
- Passes Vertical Flame Test Type A as defined in ICEA S-95-658 (6.8.2)
- UL Listed as ST1 (Limited Smoke) per UL 2556/1685
- UL Approved 90°C* for Wet and Dry Locations
- UL Listed for Sunlight Resistance (Black Only)
- Meets the requirements of NFPA 130 & 502
- Passes UL VW-1**
- For tray installation, 1/0 AWG and larger (CT USE)
- Listed as USE-2 Underground Service Entrance cable
- Passes Long-Term Water Test per AREMA 10.3.26

**Rated 90°C for normal operation in wet and dry locations, 130°C for emergency overload conditions, and 250°C for short circuit conditions.*

***10 AWG and larger*

PRODUCT MATRIX

Part Number	Size (AWG/kcmil)	Number of Strands	Insulation Thickness		Nominal Overall Diameter		Approximate Net Weight (lbs/kft)
			(inch)	(mm)	(inch)	(mm)	
P47-2014	14	7	.060	1.52	.195	5.0	30
P47-2012	12	7	.060	1.52	.21	5.3	40
P47-2010	10	7	.060	1.52	.24	6.1	55
P47-2008	8	7	.070	1.78	.29	7.4	84
P47-2006	6	7	.070	1.78	.32	8.1	121
P47-2004	4	7	.070	1.78	.37	9.4	177
P47-2002	2	7	.070	1.78	.43	10.9	265
P47-2001	1	19	.090	2.29	.51	13.0	342
P47-2110	1/0	19	.090	2.29	.55	14.0	418
P47-2120	2/0	19	.090	2.29	.59	15.0	513
P47-2130	3/0	19	.090	2.29	.64	16.3	632
P47-2140	4/0	19	.090	2.29	.70	17.8	779
P47-2250	250	37	.105	2.67	.78	19.8	934
P47-2350	350	37	.105	2.67	.88	22.4	1272
P47-2500	500	37	.105	2.67	1.01	25.7	1771
P47-2750	750	61	.120	3.05	1.22	31.0	2638

FIREWALL® TRAY CABLES INSTRUMENTATION (UNSHIELDED)

600 Volts



CONSTRUCTION

- Conductors: 18 & 16 AWG Tin Coated Copper (Class B)
- Insulation: Flame Retardant LSZH Crosslinked Polyolefin
- Cable Assembly: 2 - 37 Conductors
- Circuit Identification: Printed numbers per ICEA Method 4. Alternative colors available upon request.
- Fillers: Where required
- Binder Tape: Helically Applied Polyester
- Jacket: Black Flame Retardant LSZH Crosslinked Polyolefin

LISTINGS & STANDARDS

- Insulation in accordance with ICEA and UL standards
- Insulation is Oil and Gasoline Resistant
- Insulated conductors are UL Listed Type RFHH-2
- UL Listed Type TC (UL 1277) in accordance with NEC
- Passes IEEE 1202/FT4 Vertical Tray Flame Test and ICEA 70,000 BTU/hr Vertical Tray Flame Test (T-30-520)
- Single conductors pass Vertical Flame Test Type A as defined in ICEA S-95-658 (6.8.2)
- UL Listed as ST1 (Limited Smoke) per UL 2556/1685
- UL Approved 90°C for Wet and Dry Locations
- Jacket exceeds requirements for UL Class XL/90°C and ICEA Publication T-33-655, Type II
- UL Listed for Sunlight Resistance
- Meets the requirements of NFPA 130 & 502
- Passes Long-Term Water Test per AREMA 10.3.26

FIREWALL® TRAY CABLES INSTRUMENTATION (UNSHIELDED)

600 Volts

PRODUCT MATRIX

Part Number	Number of Conductors	Size (AWG)	Insulation Thickness		Insulated Conductor Diameter (inch)	Overall Jacket Thickness (mils)	Nominal Overall Diameter		Approximate Net Weight (lbs/kft)
			(inch)	(mm)			(inch)	(mm)	
I57-0025	2	18	.030	0.76	.11	35	0.29	7.37	42
I57-0035	3	18	.030	0.76	.11	35	0.31	7.87	53
I57-0045	4	18	.030	0.76	.11	35	0.33	8.38	65
I57-0055	5	18	.030	0.76	.11	35	0.37	9.40	76
I57-0075	7	18	.030	0.76	.11	35	0.40	10.16	98
I57-0095	9	18	.030	0.76	.11	35	0.46	11.68	127
I57-0125	12	18	.030	0.76	.11	45	0.54	13.72	168
I57-0155	15	18	.030	0.76	.11	45	0.60	15.24	206
I57-0195	19	18	.030	0.76	.11	45	0.63	16.00	248
I57-0275	27	18	.030	0.76	.11	45	0.75	19.05	340
I57-0375	37	18	.030	0.76	.11	65	0.89	22.61	485
I46-0025	2	16	.030	0.76	.12	35	0.31	7.87	52
I46-0035	3	16	.030	0.76	.12	35	0.33	8.38	67
I46-0045	4	16	.030	0.76	.12	35	0.36	9.16	83
I46-0055	5	16	.030	0.76	.12	35	0.40	10.16	98
I46-0075	7	16	.030	0.76	.12	35	0.43	10.92	127
I46-0095	9	16	.030	0.76	.12	45	0.53	13.46	176
I46-0125	12	16	.030	0.76	.12	45	0.59	14.99	220
I46-0155	15	16	.030	0.76	.12	45	0.65	16.51	270
I46-0195	19	16	.030	0.76	.12	45	0.69	17.53	327
I46-0275	27	16	.030	0.76	.12	65	0.86	21.84	487
I46-0375	37	16	.030	0.76	.12	65	0.97	24.64	640

FIREWALL® TRAY CABLES

INSTRUMENTATION (MULTI-SHIELDED PAIRS)

600 Volts

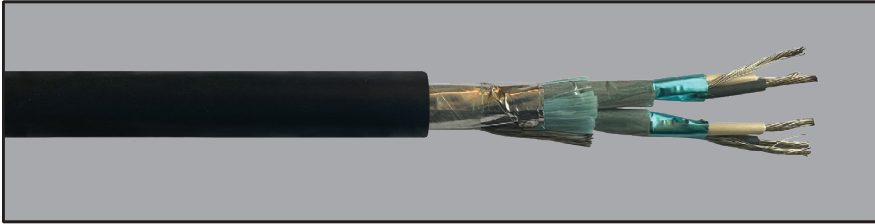

CONSTRUCTION

- Conductors: 18 & 16 AWG Tin Coated Copper (Class B)
- Insulation: Flame Retardant LSZH Crosslinked Polyolefin
- Cable Assembly: 2 - 37 Pairs
- Circuit Identification: Printed numbers per ICEA Method 4 (Alternative colors available upon request)
- Fillers: Where required
- Shield System: Helically Applied Aluminum/Polyester Laminated Tape Shield in continuous contact with Flexible Strand Tin-Coated Copper Drain Wire
- Binder Tape: Helically Applied Polyester
- Jacket: Black Flame Retardant LSZH Crosslinked Polyolefin

LISTINGS & STANDARDS

- Insulation in accordance with ICEA and UL standards
- Insulation is Oil and Gasoline Resistant
- Insulated conductors are UL Listed Type RFHH-2
- UL Listed Type TC (UL 1277) in accordance with NEC
- Passes IEEE 1202/FT4 Vertical Tray Flame Test and ICEA 70,000 BTU/hr Vertical Tray Flame Test (T-30-520)
- Single conductors pass Vertical Flame Test Type A as defined in ICEA S-95-658 (6.8.2)
- UL Listed as ST1 (Limited Smoke) per UL 2556/1685
- UL Approved 90°C* for Wet and Dry Locations
- Jacket exceeds requirements for UL Class XL/90°C and ICEA Publication T-33-655, Type II
- UL Listed for Sunlight Resistance
- Meets the requirements of NFPA 130 & 502
- Passes Long-Term Water Test per AREMA 10.3.26

FIREWALL® TRAY CABLES

INSTRUMENTATION (MULTI-SHIELDED PAIRS)

600 Volts

PRODUCT MATRIX

Part Number	Number of Pairs	Insulation Thickness		Insulated Conductor Diameter		Nominal Overall Diameter		Approximate Cable Weight	
		(inch)	(mm)	(inch)	(mm)	(inch)	(mm)	(lbs/kft)	(kg/km)
18 AWG									
I02-1801	1	.030	0.76	.110	2.69	.290	7.37	42	63
I02-1802	2	.030	0.76	.110	2.69	.481	12.22	88	131
I02-1803	3	.030	0.76	.110	2.69	.533	13.54	128	190
I02-1804	4	.030	0.76	.110	2.69	.586	14.88	160	238
I02-1805	5	.030	0.76	.110	2.69	.644	16.36	193	287
I02-1807	7	.030	0.76	.110	2.69	.705	17.91	254	378
I02-1808	8	.030	0.76	.110	2.69	.768	19.51	287	427
I02-1809	9	.030	0.76	.110	2.69	.872	22.15	356	530
I02-1812	12	.030	0.76	.110	2.69	.981	24.92	453	674
I02-1815	15	.030	0.76	.110	2.69	1.092	27.74	551	820
I02-1819	19	.030	0.76	.110	2.69	1.153	29.29	669	996
I02-1837	37	.030	0.76	.110	2.69	1.560	39.62	1221	1817
16 AWG									
I02-1601	1	.030	0.76	.120	3.00	.310	7.87	52	77
I02-1602	2	.030	0.76	.120	3.00	.544	13.82	122	182
I02-1603	3	.030	0.76	.120	3.00	.579	14.71	163	243
I02-1604	4	.030	0.76	.120	3.00	.637	16.18	206	307
I02-1605	5	.030	0.76	.120	3.00	.701	17.81	250	372
I02-1607	7	.030	0.76	.120	3.00	.769	19.53	332	494
I02-1608	8	.030	0.76	.120	3.00	.880	22.35	412	613
I02-1609	9	.030	0.76	.120	3.00	.949	24.10	459	683
I02-1612	12	.030	0.76	.120	3.00	1.069	27.15	589	877
I02-1615	15	.030	0.76	.120	3.00	1.192	30.28	719	1070
I02-1619	19	.030	0.76	.120	3.00	1.259	31.98	879	1308
I02-1637	37	.030	0.76	.120	3.00	1.770	44.96	1730	2575

FIREWALL® TRAY CABLES CONTROL

600 Volts

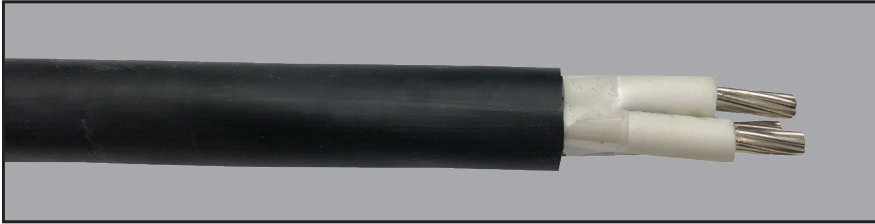

CONSTRUCTION

- Conductors: 14 - 10 AWG Tin Coated Copper (Class B)
- Insulation: Flame Retardant LSZH Crosslinked Polyolefin
- Cable Assembly: 2 - 37 Conductors
- Circuit Identification: Printed numbers per ICEA Method 4. (Alternative colors available upon request)
- Fillers: Where required
- Binder Tape: Helically Applied Polyester
- Jacket: Black Flame Retardant LSZH Crosslinked Polyolefin

LISTINGS & STANDARDS

- Insulation in accordance with ICEA and UL standards
- Insulation is Oil and Gasoline Resistant
- Insulated conductors are UL Listed Type XHHW-2
- UL Listed Type TC (UL 1277) in accordance with NEC
- Passes IEEE 1202/FT4 Vertical Tray Flame Test and ICEA 70,000 BTU/hr Vertical Tray Flame Test (T-30-520)
- Single conductors pass Vertical Flame Test Type A as defined in ICEA S-95-658 (6.8.2)
- UL Listed as ST1 (Limited Smoke) per UL 2556/1685
- UL Approved 90°C for Wet and Dry Locations
- Jacket exceeds requirements for UL Class XL/90°C and ICEA Publication T-33-655, Type II
- UL Listed for Sunlight Resistance
- Meets the requirements of NFPA 130 & 502
- Passes Long-Term Water Test per AREMA 10.3.26

FIREWALL® TRAY CABLES CONTROL

600 Volts

PRODUCT MATRIX

Part Number	Number of Conductors	Size (AWG)	Insulation Thickness		Insulated Conductor Diameter (inch)	Overall Jacket Thickness (mils)	Nominal Overall Diameter		Approximate Net Weight (lbs/kft)
			(inch)	(mm)			(inch)	(mm)	
C530021	2	14	.030	.76	.13	35	.34	8.64	67
C530031	3	14	.030	.76	.13	35	.36	9.14	86
C530041	4	14	.030	.76	.13	35	.40	10.16	110
C530051	5	14	.030	.76	.13	35	.44	11.18	133
C530071	7	14	.030	.76	.13	35	.47	11.94	170
C530091	9	14	.030	.76	.13	45	.58	14.73	235
C530121	12	14	.030	.76	.13	45	.65	16.51	295
C530191	19	14	.030	.76	.13	45	.76	19.30	444
C530251	25	14	.030	.76	.13	65	.93	23.62	616
C530371	37	14	.030	.76	.13	65	1.07	26.42	870
C520021	2	12	.030	.76	.15	35	.38	9.65	90
C520031	3	12	.030	.76	.15	35	.40	10.16	118
C520041	4	12	.030	.76	.15	35	.44	11.18	151
C520051	5	12	.030	.76	.15	35	.49	12.45	184
C520071	7	12	.030	.76	.15	45	.55	13.97	250
C520091	9	12	.030	.76	.15	45	.65	16.51	324
C520121	12	12	.030	.76	.15	45	.73	18.54	411
C520191	19	12	.030	.76	.15	65	.90	22.86	662
C520251	25	12	.030	.76	.15	65	1.05	26.67	860
C520371	37	12	.030	.76	.15	65	1.20	30.48	1225
C510021	2	10	.030	.76	.18	35	.43	10.92	125
C510031	3	10	.030	.76	.18	35	.46	11.68	165
C510041	4	10	.030	.76	.18	45	.52	13.21	225
C510051	5	10	.030	.76	.18	45	.57	14.48	275
C510071	7	10	.030	.76	.18	45	.62	15.75	360
C510091	9	10	.030	.76	.18	45	.73	18.54	460
C510121	12	10	.030	.76	.18	65	.87	22.10	625
C510191	19	10	.030	.76	.18	65	1.02	25.91	950
C510251	25	10	.030	.76	.18	65	1.19	30.23	1235
C510371	37	10	.030	.76	.18	65	1.37	34.80	1770

FIREWALL® TRAY CABLES CONTROL

2000 Volts

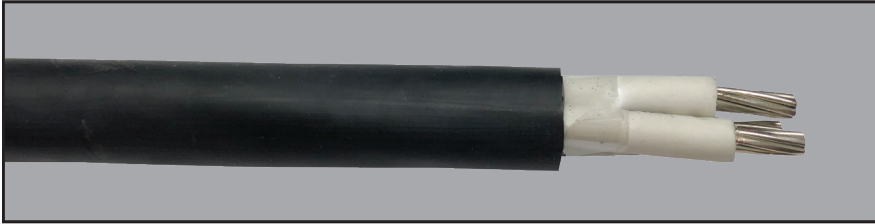

CONSTRUCTION

- Conductors: 14 - 10 AWG Tin Coated Copper (Class B)
- Insulation: Flame Retardant LSZH Crosslinked Polyolefin
- Cable Assembly: 2 - 37 Conductors
- Circuit Identification: Printed numbers per ICEA Method 4 (Alternative colors available upon request)
- Fillers: Where required
- Binder Tape: Helically Applied Polyester
- Jacket: Black Flame Retardant LSZH Crosslinked Polyolefin

LISTINGS & STANDARDS

- Insulation in accordance with ICEA and UL standards
- Insulation is Oil and Gasoline Resistant
- Insulated conductors are UL Listed Type XHHW-2
- UL Listed Type TC (UL 1277) in accordance with NEC
- Passes IEEE 1202/FT4 Vertical Tray Flame Test and ICEA 70,000 BTU/hr Vertical Tray Flame Test (T-30-520)
- Single conductors pass Vertical Flame Test Type A as defined in ICEA S-95-658 (6.8.2)
- UL Listed as ST1 (Limited Smoke) per UL 2556/1685
- UL Approved 90°C for Wet and Dry Locations
- Jacket exceeds requirements for UL Class XL/90°C and ICEA Publication T-33-655, Type II
- UL Listed for Sunlight Resistance
- Meets the requirements of NFPA 130 & 502
- Passes Long-Term Water Test per AREMA 10.3.26

FIREWALL® TRAY CABLES CONTROL

2000 Volts

PRODUCT MATRIX

Part Number	Number of Conductors	Size (AWG)	Insulation Thickness		Insulated Conductor Diameter (inch)	Overall Jacket Thickness (mils)	Nominal Overall Diameter		Approximate Net Weight (lbs/kft)
			(inch)	(mm)			(inch)	(mm)	
C560021	2	14	.045	1.14	.164	35	.40	10.24	82
C560031	3	14	.045	1.14	.164	35	.43	10.87	107
C560041	4	14	.045	1.14	.164	35	.47	11.96	135
C560051	5	14	.045	1.14	.164	45	.54	13.69	178
C560071	7	14	.045	1.14	.164	45	.59	14.96	223
C560091	9	14	.045	1.14	.164	45	.69	17.48	291
C560121	12	14	.045	1.14	.164	45	.78	19.74	365
C560191	19	14	.045	1.14	.164	65	.96	24.30	589
C560251	25	14	.045	1.14	.164	65	1.12	28.31	763
C560371	37	14	.045	1.14	.164	65	1.29	32.60	1076
C550031	3	12	.045	1.14	.18	35	.47	11.94	143
C550041	4	12	.045	1.14	.18	45	.54	13.72	193
C550051	5	12	.045	1.14	.18	45	.59	15.04	238
C550071	7	12	.045	1.14	.18	45	.65	16.43	296
C550091	9	12	.045	1.14	.18	45	.76	19.28	383
C550121	12	12	.045	1.14	.18	65	.90	22.82	523
C550191	19	12	.045	1.14	.18	65	1.05	26.76	783
C550251	25	12	.045	1.14	.18	65	1.23	31.18	1027
C550371	37	12	.045	1.14	.18	65	1.42	36.06	1448
C540031	3	10	.045	1.14	.21	45	.54	13.77	203
C540041	4	10	.045	1.14	.21	45	.60	15.11	258
C540051	5	10	.045	1.14	.21	45	.65	16.61	320
C540071	7	10	.045	1.14	.21	45	.72	18.19	404
C540091	9	10	.045	1.14	.21	65	.88	22.42	559
C540121	12	10	.045	1.14	.21	65	1.00	25.26	710
C540191	19	10	.045	1.14	.21	65	1.17	29.68	1074
C540251	25	10	.045	1.14	.21	65	1.37	34.66	1412
C540371	37	10	.045	1.14	.21	65	1.58	40.14	2007

FIREWALL® TRAY CABLES POWER

600 Volts



CONSTRUCTION

- Conductors: 14 AWG - 500 kcmil Tin Coated Copper (Class B)
- Insulation: Flame Retardant LSZH Crosslinked Polyolefin
- Cable Assembly: 2 - 4 Conductors
- Circuit Identification: Printed numbers per ICEA Method 4 (Alternative colors available upon request)
- Fillers: Where required
- Ground Wire(s): Annealed Copper Class B to comply with NEC requirements
- Binder Tape: Helically Applied Polyester
- Jacket: Black Flame Retardant LSZH Crosslinked Polyolefin

LISTINGS & STANDARDS

- Insulation in accordance with ICEA and UL standards
- Insulation is Oil and Gasoline Resistant
- Insulated conductors are UL Listed Type XHHW-2
- UL Listed Type TC (UL 1277) in accordance with NEC
- Passes IEEE 1202/FT4 Vertical Tray Flame Test and ICEA 70,000 BTU/hr Vertical Tray Flame Test (T-30-520)
- Single conductors pass Vertical Flame Test Type A as defined in ICEA S-95-658 (6.8.2)
- UL Listed as ST1 (Limited Smoke) per UL 2556/1685
- UL Approved 90°C for Wet and Dry Locations
- Jacket exceeds requirements for UL Class XL/90°C and ICEA Publication T-33-655, Type II
- UL Listed for Sunlight Resistance
- Meets the requirements of NFPA 130 & 502
- Passes Long-Term Water Test per AREMA 10.3.26

FIREWALL® TRAY CABLES POWER

600 Volts

PRODUCT MATRIX

Part Number	Size (AWG/kcmil)	Number of Strands	Insulation Thickness		Ground Wires Qty-Size	Jacket Thickness (mils)	Nominal OD		Approximate Net Weight (lbs/kft)
			(inch)	(mm)			(inch)	(mm)	
2 Conductors									
P62-2140	14	7	.030	.76	2-16 AWG	35	.345	8.76	80
P62-2120	12	7	.030	.76	2-14 AWG	35	.385	9.78	110
P62-2100	10	7	.030	.76	2-12 AWG	35	.430	10.92	160
3 Conductors									
P62-3140	14	7	.030	.76	3-18 AWG	35	.36	9.14	105
P62-3120	12	7	.030	.76	3-16 AWG	35	.40	10.16	140
P62-3100	10	7	.030	.76	3-14 AWG	35	.45	11.43	205
P62-3080	8	7	.045	.76	3-14 AWG	45	.61	15.49	315
P62-3060	6	7	.045	.76	3-12 AWG	45	.69	17.53	455
P62-3040	4	7	.045	.76	3-12 AWG	45	.79	20.07	630
P62-3020	2	7	.045	.76	3-10 AWG	65	.96	24.38	980
P62-3001	1	19	.055	1.40	3-10 AWG	65	1.08	27.43	1200
P62-3110	1/0	19	.055	1.40	3-10 AWG	65	1.17	29.72	1440
P62-3210	2/0	19	.055	1.40	3-10 AWG	65	1.26	32.00	1740
P62-3311	3/0	19	.055	1.40	3-8 AWG	65	1.37	34.80	2170
P62-3410	4/0	19	.055	1.40	3-8 AWG	65	1.49	37.85	2627
P62-3250	250	37	.065	1.65	3-8 AWG	95	1.70	43.18	3200
P62-3350	350	37	.065	1.65	3-6 AWG	95	1.92	48.77	4350
P62-3500	500	37	.065	1.65	3-6 AWG	95	2.20	55.80	5925
4 Conductors									
P62-4012	12	7	.030	.76	3-16 AWG	35	.44	11.18	195
P62-4010	10	7	.030	.76	3-14 AWG	35	.52	13.21	290
P62-4008	8	7	.045	.76	2-12 AWG	45	.67	17.02	410
P62-4006	6	7	.045	.76	2-10 AWG	45	.76	19.30	590
P62-4004	4	7	.045	.76	2-10 AWG	65	.91	23.11	870
P62-4002	2	7	.045	.76	2-8 AWG	65	1.05	26.67	1285
P62-4001	1	19	.055	1.40	2-8 AWG	65	1.19	30.23	1580
P62-4100	1/0	19	.055	1.40	2-8 AWG	65	1.29	32.77	1900
P62-4200	2/0	19	.055	1.40	2-8 AWG	65	1.40	35.56	2300
P62-4300	3/0	19	.055	1.40	2-7 AWG	65	1.52	38.61	2865
P62-4400	4/0	19	.055	1.40	2-7 AWG	95	1.72	43.69	3605
P62-4250	250	37	.065	1.65	2-6 AWG	95	1.90	48.26	4240
P62-4350	350	37	.065	1.65	2-6 AWG	95	2.13	54.10	5675
P62-4500	500	37	.065	1.65	2-6 AWG	95	2.44	61.98	7885

HUB-Link® OVERVIEW

ABOUT HUB-Link® PRODUCTS

The HUB-Link® product portfolio consists of cables for telecommunications, data communications, and signal applications. These cables provide the medium to transmit analog and digital data at low voltage power to support various telephone circuits and general communication services throughout the transit infrastructure, as well as other outside and tunnel applications. Cables rated to 150V, 300V, 600V, 1KV, and 2KV are available.

FEATURES & BENEFITS

- Sunlight Resistant
- Rodent, Petrochemical, and Moisture Resistant
- Meets NFPA 130 & 502
- Meets IEEE 585
- Meets IEEE 1202/FT-4 per UL 2556/1685

APPLICATIONS

HUB-Link® Communications Cables

- Emergency Telephones & Public Address Systems
- Power over Ethernet (PoE) & Point of Sale (POS) Applications
- Backbone Systems
- Loudspeakers
- Camera Power Circuits
- Video & Data Transfer
- Electronic Signage
- Fare Collection Systems

HUB-Link® Signal Cables

- Transit Control Rooms & Operational Control Centers
- Wayside, Tower, and Case
- Trackside Signal Equipment

HUB-Link® Case Wire

- Bungalow Electronics Equipment
- Trackside Applications
- Relay & Signal Apparatus Wiring

OTHER CAPABILITIES

In addition to the cables listed in this section, other capabilities include:

- Continuously Corrugated Welded (CCW) RS485 Cables for Security & Intrusion Detection Applications
- Aluminum Interlock Armor (AIA) Trackside Multipair Telecom Cables for Telephone, DSL, VoIP, and 10BaseT Ethernet
- CCW Signal Code Cables for Switch & Signal Communications
- CCW, ACW, or AIA Cat 6 Cables for Data Network, Power over Ethernet (PoE), Point of Sale, and Surveillance Camera Applications
- Individually Shielded Multiconductor Cables for Corrosion Protection
- Cables meeting New York City Transit (NYCT) Spec TC-7

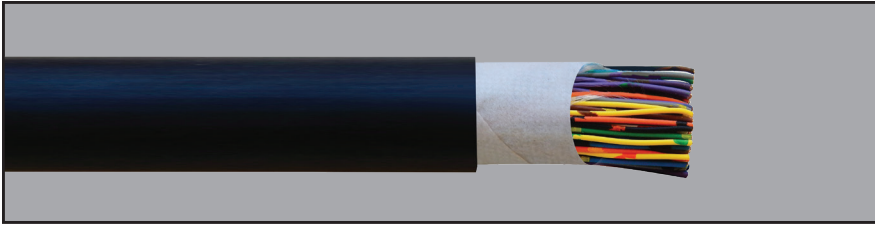

CONSTRUCTION*

- Conductors: 22 AWG Solid Bare Copper
- Insulation: Crosslinked Polyolefin
- Cable Assembly: 2 - 200 Pairs or 2 - 8 Conductors
- Tape 1: Aramid Tape
- Tape 2: Fiberglass Tape
- Jacket: Gray or Black LSZH Polyolefin (Alternative colors available upon request)

LISTINGS & STANDARDS

- c(UL)us Listed Type CMG-ST1
- UL CL3-ST1, FPL-ST1
- UL 444 Communications Cables
- UL 13 Power-Limited Circuit Cables
- UL 1424 Power-Limited Fire Alarm Circuits
- IEEE 1202-1991 & FT4 per UL 2556/1685
- NFPA 130 & 502
- UL Approved 90°C
- For Use in Wet Locations per UL 13 & 1424
- California State Fire Marshal Approved
- RoHS Compliant

*Shielded and unshielded designs are available. Additional configurations possible. Contact us for more details.

MULTIPAIR PRODUCT MATRIX

Part Number*	Number of Pairs	Size (AWG)	Nominal Diameter Insulated Conductor		Nominal Overall Diameter		Approximate Net Weight (lbs/kft)
			(inch)	(mm)	(inch)	(mm)	
35957	2	22	0.047	1.19	.265	6.73	40
35958	4	22	0.044	1.12	.288	7.32	50
35959	6	22	0.045	1.14	.351	8.92	72
35960	12	22	0.047	1.19	.453	11.51	113
35961	25	22	0.044	1.12	.560	14.22	190
35962	50	22	0.044	1.12	.868	22.05	352
35963	100	22	0.044	1.12	.990	25.15	605

*Part numbers listed are for the gray jacketed constructions. For an alternative jacket color, please contact us.

MULTICONDUCTOR PRODUCT MATRIX

Part Number*	Number of Conductors	Size (AWG)	Conductor Type	Stranding	Nominal Diameter Insulated Conductor		Nominal Overall Diameter		Approximate Net Weight (lbs/kft)
					(inch)	(mm)	(inch)	(mm)	
Shielded									
40073	2	18	Solid	-	0.076	1.93	0.227	5.77	30
40120	8	18	Solid	-	0.076	1.93	0.325	8.26	76
40093	2	16	Solid	-	0.087	2.21	0.248	6.30	40
40110	4	16	Solid	-	0.087	2.21	0.283	7.19	61
40100	4	18	Stranded	7	0.080	2.03	0.267	6.78	45
40045	6	18	Stranded	7	0.090	2.29	0.343	8.71	68
40021	2	16	Stranded	19	0.092	2.34	0.256	6.50	41
40131	4	14	Stranded	19	0.118	3.00	0.373	9.47	89
40055	3	12	Stranded	19	0.124	3.15	0.351	8.92	100
Unshielded									
40003	2	18	Stranded	7	0.082	2.08	0.233	5.92	26
40095	3	18	Stranded	7	0.082	2.08	0.245	6.22	34
40096	4	18	Stranded	7	0.082	2.08	0.266	6.76	42
40004	6	18	Stranded	7	0.082	2.08	0.314	7.98	59
40118	2	16	Stranded	19	0.094	2.39	0.256	6.50	35
40018	4	14	Stranded	19	0.118	3.00	0.363	9.22	87
40016	3	12	Stranded	19	0.124	3.15	0.346	8.79	91

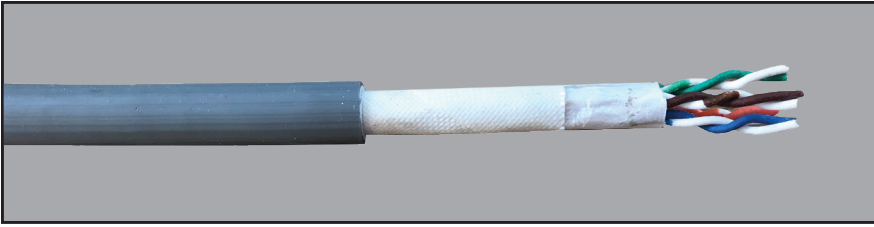

CONSTRUCTION

- Conductors: 24 AWG (Cat 5e) & 23 AWG (Cat 6/6A) Solid Bare Copper
- Insulation: Crosslinked Polyolefin
- Cable Assembly: 4 Pairs
- Tape 1: Aramid Tape
- Tape 2: Flame Retardant Woven Fabric
- Drain Wire: 24 AWG Tinned Copper (Shielded Constructions Only)
- Shield: Aluminum/Polyester (Shielded Constructions Only)
- Jacket: Gray UV Resistant LSZH (Alternative colors available upon request)

LISTINGS & STANDARDS

- ICEA S-116-732 (Cat 6A & 6)
- ICEA S-90-661 (Cat 5e)
- ETL Verified to ANSI/TIA-568-C.2
- UL 444 Communications Cables
- UL 13 Power-Limited Circuit Cables
- c(UL)us Listed Type CMG-ST1
- UL Listed Type CL3-ST1
- UL 1685, FT-4 Vertical Flame
- IEEE 1202
- NFPA 70 (NEC) Article 800
- NFPA 130 & 502
- NES 713 for Toxicity Index < 2.0%
- MIL-C-24643 Halogen Content < 0.2%
- Acid Gas Content < 2.0%
- ICEA T-33-655 (Smoke for Thermoplastic Type II Jackets)
- NEMA 63.1
- UL Approved 90°C
- For Use in Wet Locations
- California State Fire Marshal Approved
- RoHS Compliant

PRODUCT MATRIX

Part Number*	Category	Shielded or Unshielded	Number of Pairs	Size (AWG)	Nominal Diameter Insulated Conductor		Nominal Overall Diameter		Approximate Net Weight (lbs/kft)
					(inch)	(mm)	(inch)	(mm)	
40083	5e	Unshielded	4	24	.035	.889	.259	6.58	37
35978	5e	Shielded	4	24	.041	1.04	.288	7.32	43
35977	6	Unshielded	4	23	.043	1.09	.297	7.54	48
36264	6	Shielded	4	23	.045	1.14	.345	8.76	57
36473	6A	Shielded	4	23	.045	1.14	.363	9.22	64

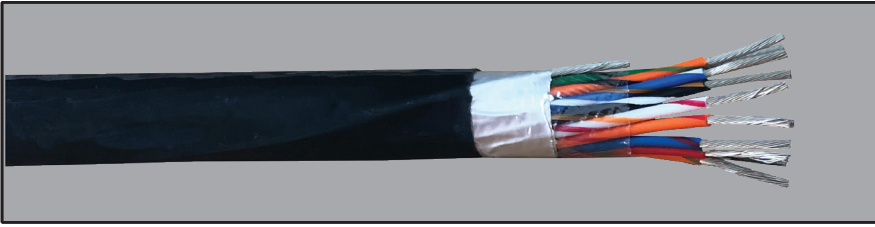

CONSTRUCTION

- Conductors: 30 AWG - 500 kcmil Solid or Stranded Copper
- Insulation: ETFE
- Cable Assembly: Single Conductor, Multiconductor, or Pairs
- Shield: Available Upon Request
- Jacket: LSZH Polyolefin

LISTINGS & STANDARDS

- NEMA HP100, High Temperature Instrument and Control Cable
- NEMA HP100.2, High Temperature Instrument and Control Cable Insulated and Jacket with ETFE Fluoropolymers
- Non-Flame Propagating, IEC 60332-1, IEC 60332-3C, VW1
- RoHS Compliant

SINGLE CONDUCTOR PRODUCT MATRIX

Part Number	Size (AWG/kcmil)	Strand	Type	Diameter (inch)	Wall (inch)	Nominal OD (inch)	Voltage Rating*
49000	24	19/36	UNI	0.0236	0.010	0.0436	150
49001	22	19/34	UNI	0.0296	0.010	0.0496	150
49002	22	7/30	CON	0.0309	0.010	0.0509	150
49003	20	19/32	UNI	0.0378	0.010	0.0578	150
49004	18	19/30	UNI	0.0467	0.010	0.0667	150
49005	16	19/.0117	UNI	0.0530	0.010	0.0730	150
49006	30	1	Solid	0.0103	0.006	0.0223	300
49007	28	1	Solid	0.0130	0.006	0.0250	300
49008	26	1	Solid	0.0164	0.006	0.0284	300
49009	24	1	Solid	0.0207	0.006	0.0327	300
49010	22	1	Solid	0.0261	0.006	0.0381	300
49011	20	1	Solid	0.0329	0.006	0.0449	300
49012	24	19/36	UNI	0.0236	0.012	0.0476	300
49013	22	19/34	UNI	0.0296	0.012	0.0536	300
49014	22	7/30	CON	0.0309	0.012	0.0549	300
49015	20	19/32	UNI	0.0380	0.012	0.0620	300
49016	18	19/30	UNI	0.0467	0.012	0.0707	300
49017	16	19/.0117	UNI	0.0530	0.012	0.0770	300
49018	14	19/.0147	UNI	0.0662	0.012	0.0902	300
49019	14	37/30	CON	0.0710	0.012	0.0950	300
49020	24	19/36	UNI	0.0236	0.0150	0.0536	600
49021	22	19/34	UNI	0.0296	0.0150	0.0596	600
49022	22	7/30	CON	0.0309	0.0150	0.0609	600
49023	20	19/32	UNI	0.0380	0.0155	0.0690	600
49024	18	19/30	UNI	0.0480	0.0150	0.0780	600
49025	16	19/.0117	UNI	0.0550	0.0160	0.0870	600
49026	14	19/.0147	UNI	0.0690	0.0160	0.1010	600
49027	14	37/30	CON	0.0710	0.0150	0.1010	600
49028	12	37/.0133	CON	0.0910	0.0160	0.1230	600
49029	10	37/.0167	CON	0.1130	0.0200	0.1530	600
49030	9	37/.0190	CON	0.1290	0.0170	0.1630	600
49031	9	19 x 7/.010	UNI/ROPE	0.1480	0.0170	0.1820	600
49032	8	19 x 7/29	UNI/ROPE	0.1620	0.0170	0.1960	600
49033	6	19 x 7/27	UNI/ROPE	0.2030	0.0210	0.2450	600
49034	4	19 x 7/25	UNI/ROPE	0.2600	0.0240	0.3080	600
49035	2	19 x 35/30	CON/ROPE	0.3310	0.0260	0.3830	600
49036	1	19 x 43/30	CON/ROPE	0.3600	0.0280	0.4160	600
49037	1/0	19 x 55/30	CON/ROPE	0.4180	0.0300	0.4780	600
49038	2/0	19 x 70/30	CON/ROPE	0.4640	0.0390	0.5420	600
49039	3/0	37 x 45/30	CON/ROPE	0.5310	0.0500	0.6310	600
49040	4/0	37 x 57/30	CON/ROPE	0.5980	0.0500	0.6980	600
49041	500	7 x 19 x 38/30	BUN/ROPE	0.9880	0.0500	1.0880	600

MULTIPAIR & MULTICONDUCTOR PRODUCT MATRIX*

Part Number	Number of Pairs/ Conductors	Size (AWG/kcmil)	Strand	Type	Diameter (inch)	Wall (inch)	Nominal OD (inch)	Voltage Rating
49042	1 Pair	24	19/36	UNI	0.0236	0.015	0.0536	600
49043	1 Pair	22	19/34	UNI	0.0296	0.015	0.0596	600
49044	1 Pair	22	7/30	CON	0.0309	0.015	0.0609	600
49045	1 Pair	20	19/32	UNI	0.0378	0.015	0.0678	600
49046	1 Pair	18	19/30	UNI	0.0467	0.015	0.0767	600
49047	1 Pair	16	19/.0117	UNI	0.0550	0.017	0.0880	600
49048	1 Pair	14	19/.0147	UNI	0.0700	0.016	0.1010	600
49049	1 Pair	14	37/30	CON	0.0710	0.015	0.1010	600
49050	1 Pair	12	37/.0133	CON	0.0910	0.016	0.1230	600
49051	1 Pair	10	37/.0167	CON	0.1130	0.020	0.1530	600
49052	1 Pair	9	37/.0190	CON	0.1290	0.017	0.1630	600
49053	1 Pair	9	19 x 7/.010	UNI/ROPE	0.1480	0.017	0.1820	600
49054	1 Pair	8	19 x 7/29	UNI/ROPE	0.1620	0.017	0.1960	600
49055	1 Pair	6	19 x 7/27	UNI/ROPE	0.2030	0.020	0.2430	600
49056	1 Pair	4	19 x 7/25	UNI/ROPE	0.2600	0.024	0.3080	600
49057	1 Pair	2	19 x 35/30	CON/ROPE	0.3310	0.026	0.3830	600
49058	1 Pair	1	19 x 43/30	CON/ROPE	0.3600	0.028	0.4160	600
49059	1 Pair	1/0	19 x 55/30	CON/ROPE	0.4180	0.030	0.4780	600
49060	1 Pair	2/0	19 x 70/30	CON/ROPE	0.4640	0.039	0.5420	600
49061	1 Pair	3/0	37 x 45/30	CON/ROPE	0.5310	0.050	0.6310	600
49062	1 Pair	4/0	37 x 57/30	CON/ROPE	0.5980	0.050	0.6980	600
49063	1 Pair	500	7 x 19 x 38/30	BUN/ROPE	0.9880	0.050	1.0880	600
49064	3 Cond.	12	37/.0133	CON	0.0872	0.015	0.29	600

*Constructions listed are for unshielded, non-jacketed constructions. Shielded and jacketed designs are also available.

HUB-Link® CASE WIRE

600 Volts

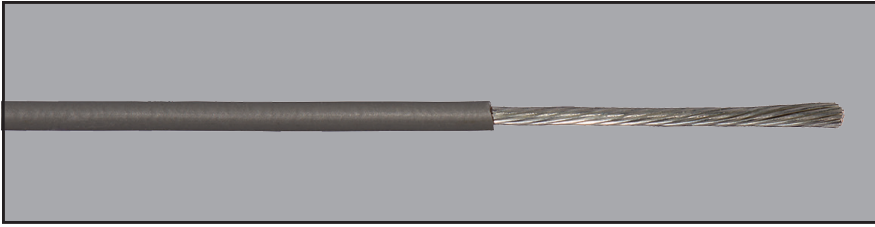

CONSTRUCTION

- Conductors: 22 - 10 AWG Tin Coated Copper (Class B)
- Insulation: Crosslinked Polyolefin
- Jacket: Crosslinked Modified Fluoropolymer

LISTINGS & STANDARDS

- AREMA MP 10.03.27 Recommended Design Criteria for Crosslinked Polyolefin/Fluoropolymer Insulation for 125°C Wire
- AREMA MP 10.03.15 Recommended Design Criteria for Insulated Signal Wire/Case Wire
- Temperature Rating 125°C
- Low Temperature Rating -55°C
- Passes UL VW-1
- Meets toxicity requirements when tested in accordance with BSS 7239
- Meets transit smoke requirements when tested in accordance with ASTM E662
- Passes UL 1685 in accordance with NFPA 130 with IEEE 1202/FT4 Flame Test

PRODUCT MATRIX

Part Number*	Conductor Size (AWG/mm)		Stranding	Nominal Conductor Diameter (inch)	Insulation Thickness (inch)	Nominal Overall Diameter (inch)	Approximate Net Weight (lbs/kft)
CW01022-270	22	.38	19/34	0.030	0.015	0.060	3.7
CW01020-270	20	.62	19/32	0.038	0.015	0.068	5.4
CW01018-270	18	.96	19/30	0.047	0.015	0.077	7.7
CW01016-270	16	1.23	19/29	0.054	0.015	0.084	9.6
CW01014-270	14	1.94	19/27	0.067	0.015	0.097	14.3
CW01012-270	12	3.08	19/25	0.085	0.015	0.115	22.2
CW01010-270	10	4.74	27/24	0.116	0.015	0.151	39.3

*The catalog part numbers are for black insulation. Please see color chart below.

0	Black
1	Brown
2	Red
3	Orange
4	Yellow
5	Green
6	Blue
7	Violet
8	Gray
9	White

For example: 1/C 16 AWG Red part number is CW01016-272



CONTACT US

Comtran

330A Turner Street

Attleboro, MA 02703

Toll Free: 800-842-7809

Email: sales@comtrancorp.com

www.comtrancorp.com



RSCC

20 Bradley Park Road

East Granby, CT 06026

Toll Free: 800-327-7625

Email: rsc-sales@r-scc.com

www.r-scc.com

